

Vaš pouzdan partner u ekološki odgovornim rješenjima za skladištenje, transport i gospodarenje
otpadom



FINNCONY[®]

1/42

Finncont[®] Luowia

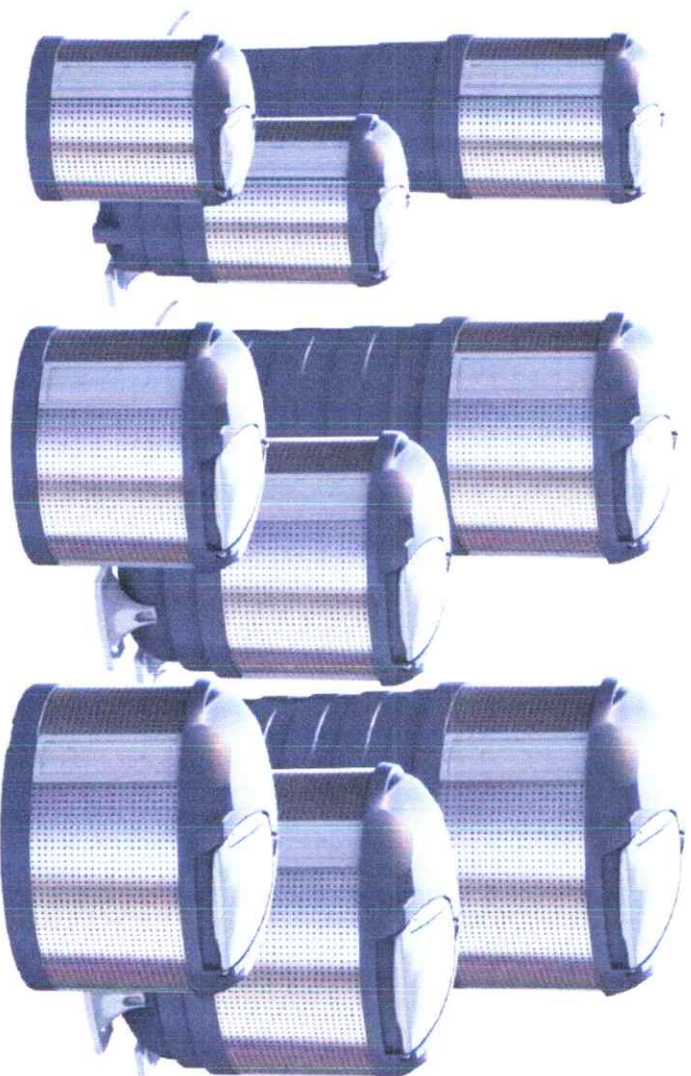

FINNCONY[®]

CONTINUITY

Finncont® Luowia

Sustavi gospodarenja otpadom

Najmoderniji i najsigurniji izbor kada trebate rješenje za gospodarenje otpadom većih količina

Pogodni za velike, kao i za manje površine

Mogućnost prilagodbe različitim panelima kako bi se što bolje uklopili u okolinu

Testirani sukladno standardima
EN-13071-1 / 13071-2 / 13071-3

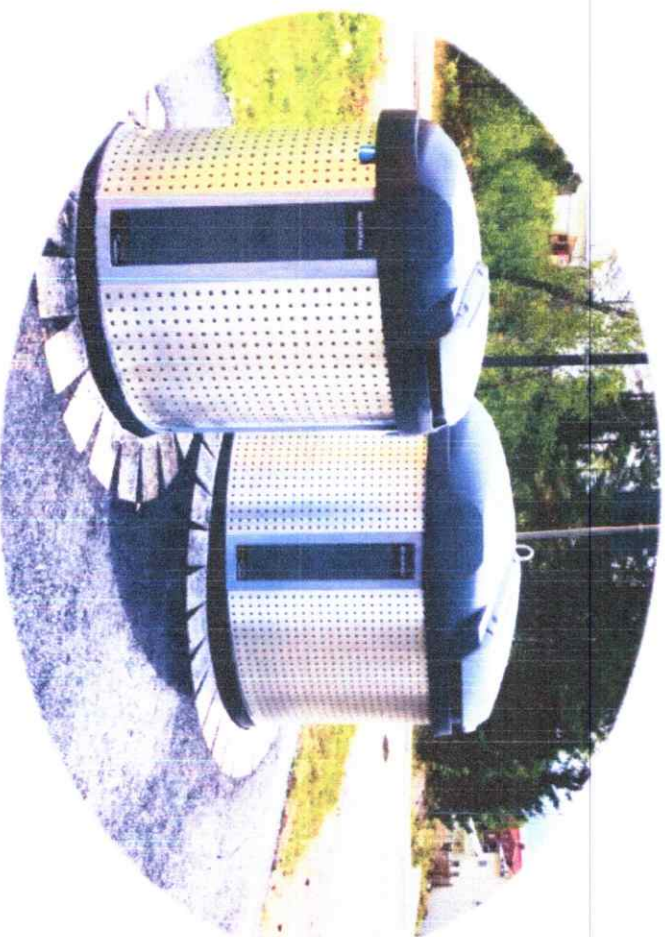

Finncont® Luowia

Proizvodni asortiman

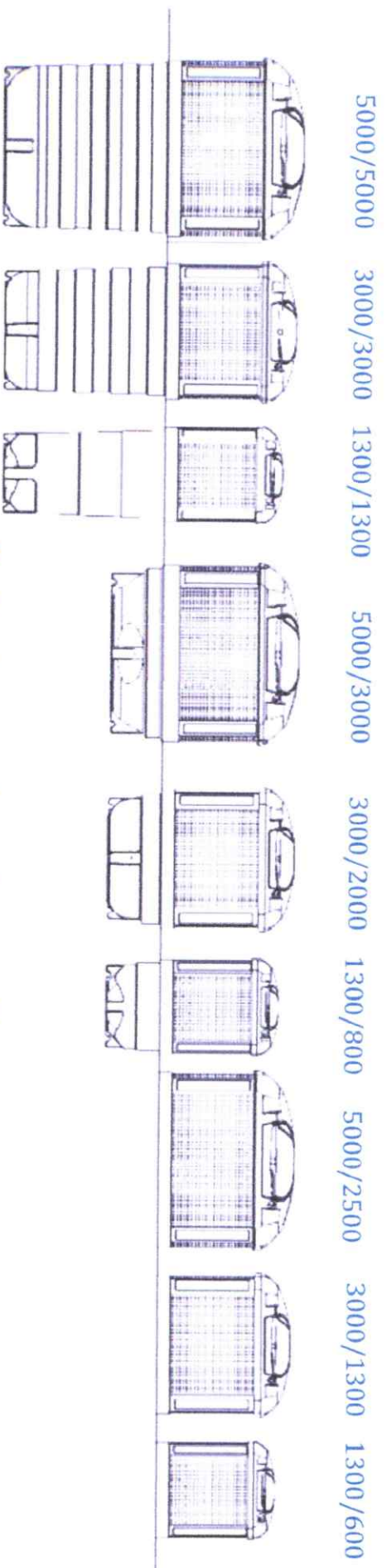

Sustavi gospodarenja otpadom

FINNCONT®

CONTINUITY

Finncont® Luowia Deep – podzemni

Sustavi gospodarenja otpadom

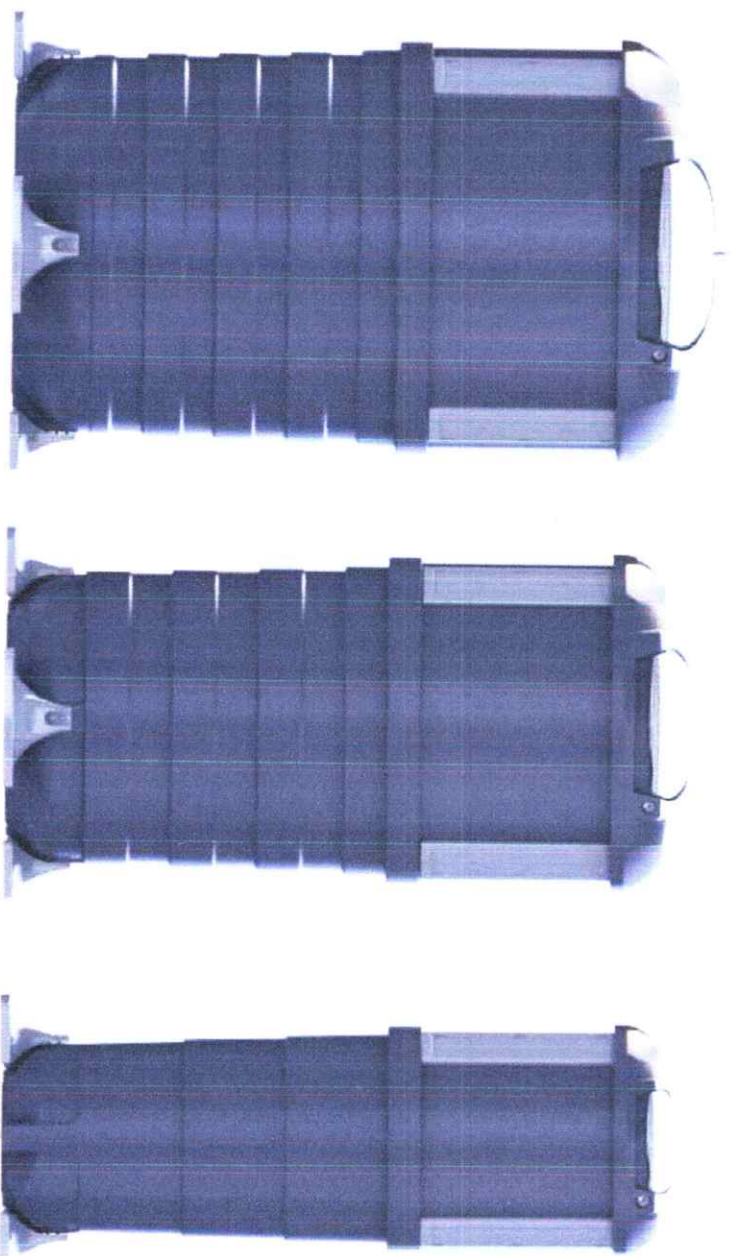

FINNCONT®

CONTINUITY

Finncont® Luowia 5000/5000 Deep

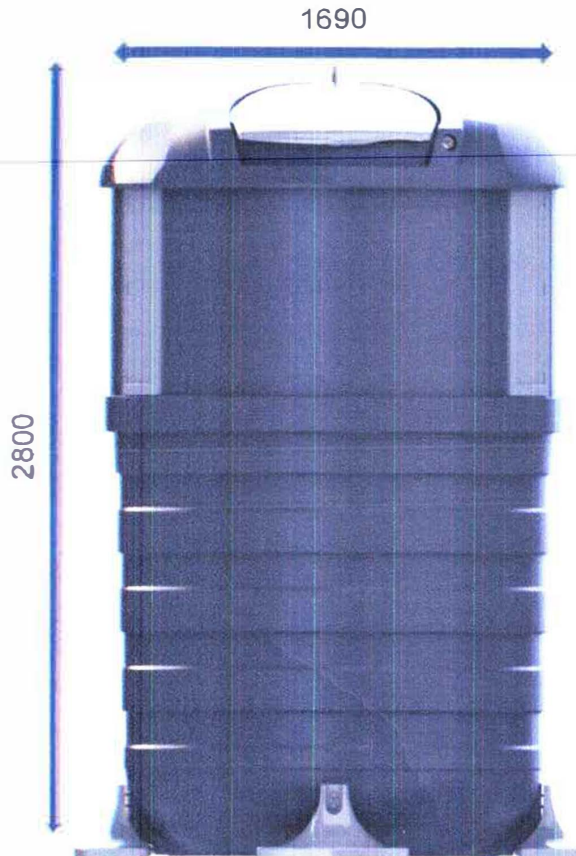

Proizvod

Finncont® Luowia 5000/5000 Deep

Volumen (l)

5000

Dimenzija poklopca za ubacivanje (mm)

600

Ø (mm)

1690

Visina (mm)

1250

Ukupna visina (mm)

2800

Težina (kg)

150

Dubina instalacije (m)

1,5

Sustav za sidrenje

4 nožice (peraje)

Materijal

Polietilen visoke gustoće HDPE

Boja tijela i poklopca

Antracit, boja pijeska (bež), siva

Finncont® Luowia 3000/3000 Deep

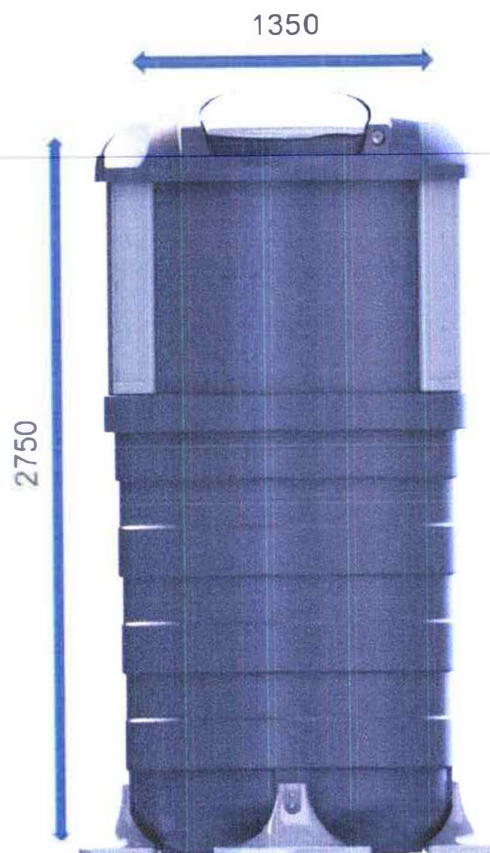

Proizvod

Finncont® Luowia 3000/3000 Deep

Volumen (l)

3000

Dimenzija poklopca za ubacivanje (mm)

450

Ø (mm)

1350

Visina (mm)

1220

Ukupna visina (mm)

2750

Težina (kg)

130

Dubina instalacije (m)

1,5

Sustav za sidrenje

4 nožice (peraje)

Materijal

Polietilen visoke gustoće HDPE

Boja tijela i poklopca

Antracit, boja pijeska (bež), siva

Finncont® Luowia 1300/1300 Deep

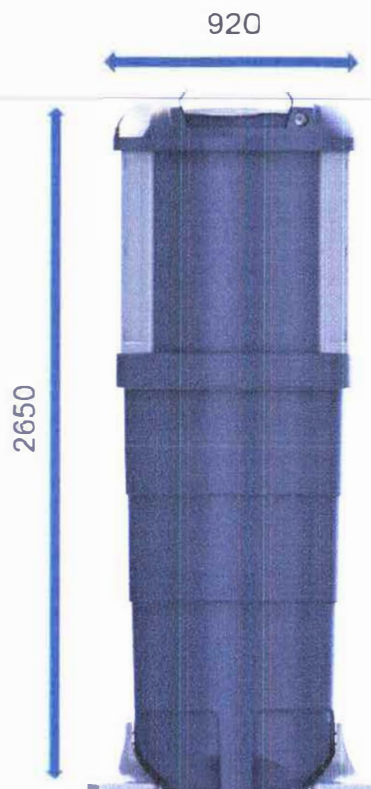

Proizvod

Finncont® Luowia 1300/1300 Deep

Volumen (l)

1300

Dimenzije poklopca za ubacivanje (mm)

300

Ø (mm)

920

Visina (mm)

1150

Ukupna visina (mm)

2650

Težina (kg)

120

Dubina instalacije (m)

1,5

Sustav za sidrenje

2 nožice (peraje)

Materijal

Polietilen visoke gustoće HDPE

Boja tijela i poklopca

Antracit, boja pijeska (bež), siva

Finncont® Luowia **Short** - podzemni

8/42

Sustavi gospodarenja odpadom

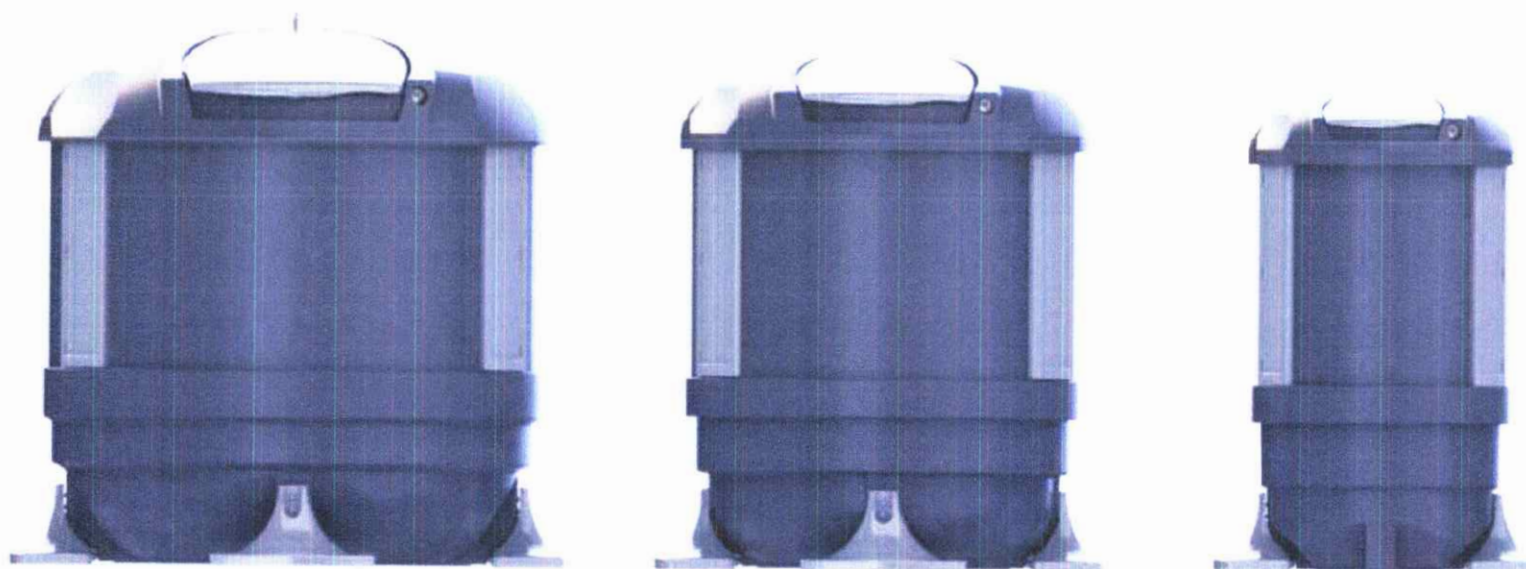

FINNCONT®

CONTINUITY

Finncont® Luowia 5000/3000 Short

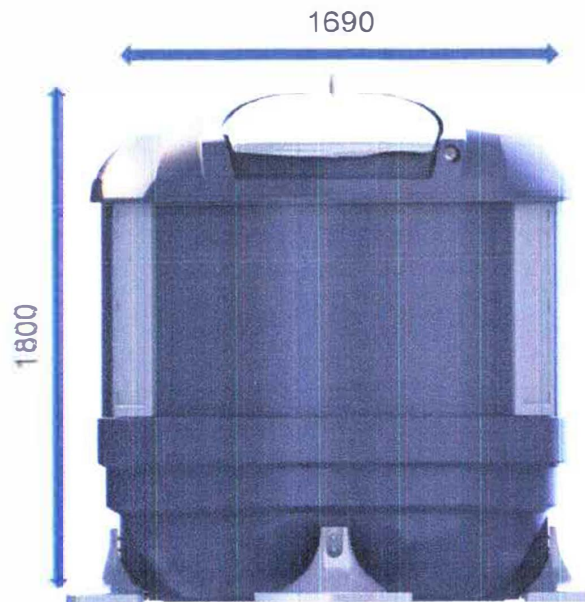

Proizvod

Finncont® Luowia 5000/3000 hort

Težina (kg)

130

Volumen (l)

3000

Dubina instalacije (m)

0,5

Dimenzija poklopca za ubacivanje (mm)

600

Sustav za sidrenje

4 nožice (peraje)

Ø (mm)

1690

Materijal

Polietilen visoke gustoće HDPE

Visina (mm)

1250

Boja tijela i poklopca

Antracit, boja pijeska (bež),
siva

Ukupna visina (mm)

1800

Finncont® Luowia 3000/2000 Short

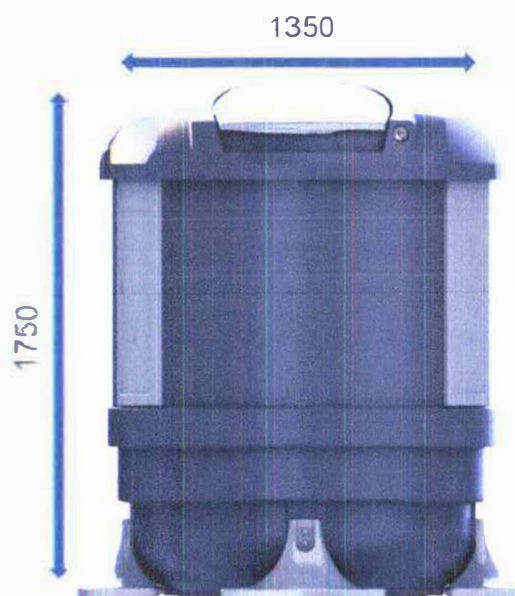

Proizvod

Finncont® Luowia 3000/2000 Short

Težina (kg)

110

Volumen (l)

2000

Dubina instalacije (m)

0,5

Dimenzija poklopca za ubacivanje (mm)

450

Sustav za sidrenje

4 nožice (peraje)

Ø (mm)

1350

Materijal

Polietilen visoke gustoće HDPE

Visina (mm)

1220

Boja tijela i poklopca

Antracit, boja pijeska (bež) ,
siva

Ukupna visina (mm)

1750

Finncont® Luowia 1300/800 Short

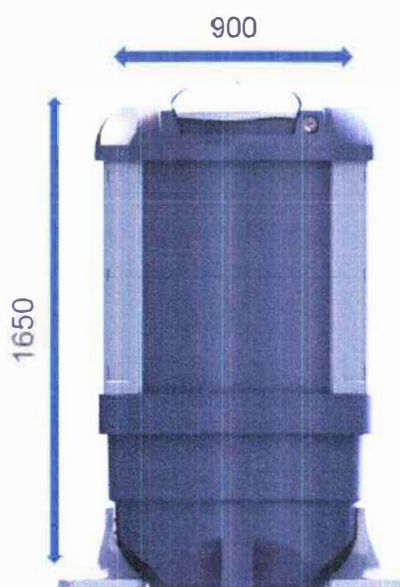

Proizvod

Finncont® Luowia 1300/800 short

Težina (kg)

90

Volumen(l)

500

Dubina instalacije (m)

0,5

Dimenzija poklopca za ubacivanje(mm)

300

Sustav za sidrenje

2 nožice (peraje)

Ø (mm)

900

Materijal

Polietilen visoke gustoće HDPE

Visina (mm)

1150

Boja tijela i poklopca

Antracit, boja pijeska

Ukupna visina(mm)

1650

(bež), siva

Finncont® Luowia **Surface** - nadzemni

Sustavi gospodarenja odpadom

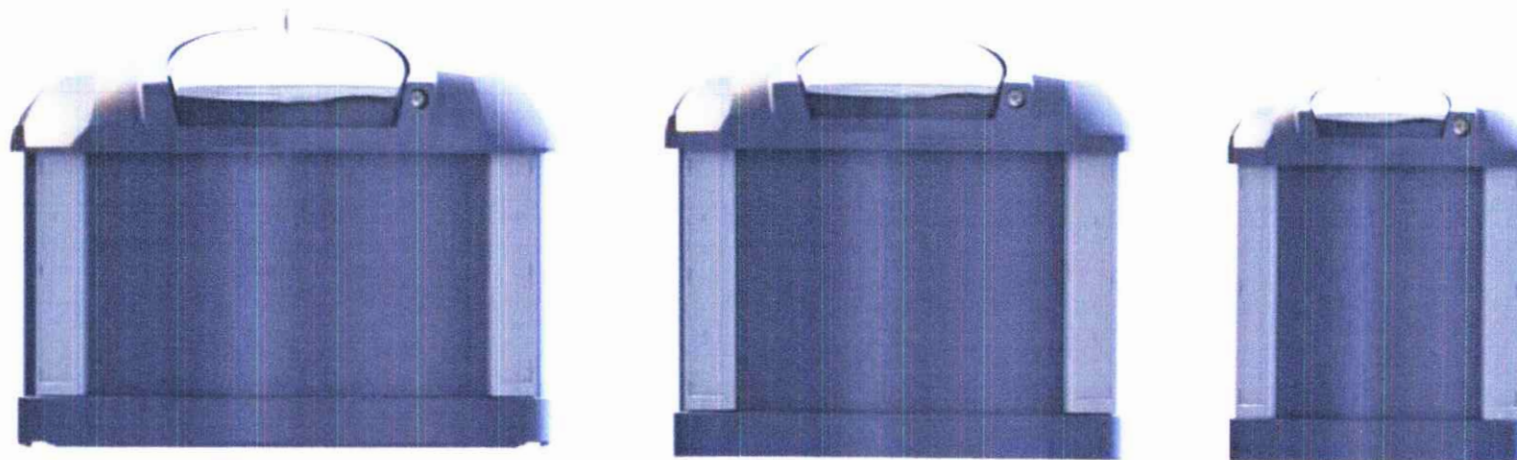

FINNCONT®

CONTINUITY

Finncont® Luowia 5000/2500 Surface

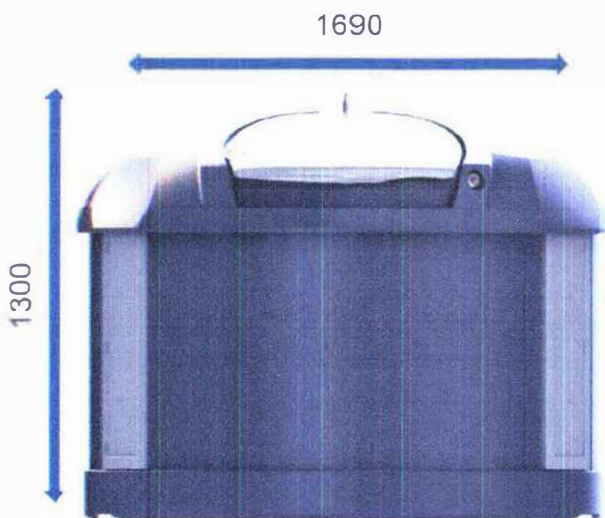

Proizvod

Finncont® Luowia 5000/2500 Surface

Težina (kg)

110

Volumen (l)

2500

Dubina instalacije (m)

nadzemni

Dimenzija poklopca za ubacivanje (mm)

600

Sustav za sidrenje

4 betonske ploče (opcija)

Ø (mm)

1690

Materijal

Polietilen visoke gustoće HDPE

Visina (mm)

1200

Boja tijela i poklopca

Antracit, boja pijeska (bež), siva

Ukupna visina (mm)

1300

Finncont® Luowia 3000/1300 Surface

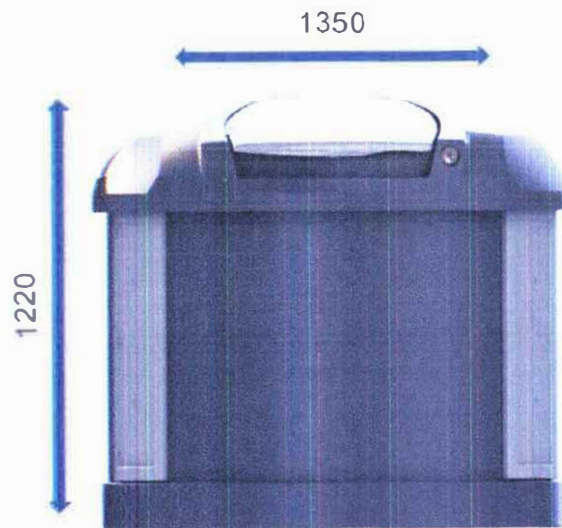

Proizvod

Finncont® Luowia 3000/1300 Surface

Težina (kg)

90

Volumen (l)

1300

Dubina instalacije (m)

nadzemni

Dimenzija poklopca za ubacivanje (mm)

450

Sustav za sidrenje

2 betonske ploče (opcija)

Ø (mm)

1350

Materijal

Polietilen visoke gustoće HDPE

Visina (mm)

1200

Boja tijela i poklopca

Antracit, boja pijeska (bež), siva

Ukupna visina (mm)

1220

Finncont® Luowia 1300/600 Surface

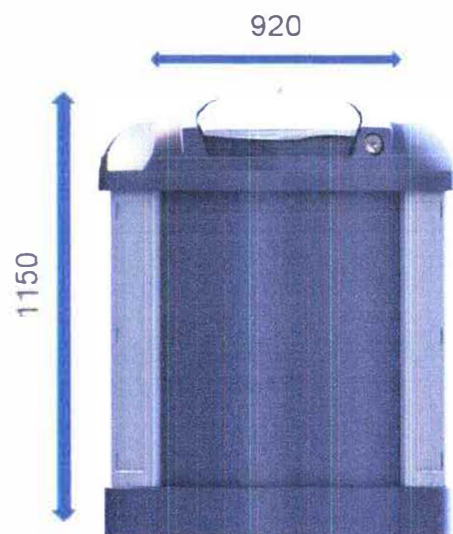

Proizvod

Finncont® Luowia 1300/600 Surface

Težina (kg)

70

Volumen (l)

600

Dubina instalacije (m)

nadzemni

Dimenzija poklopca za ubacivanje (mm)

300

Sustav za sidrenje

1 betonska ploča (opcija)

Ø (mm)

920

Materijal

Polietilen visoke gustoće HDPE

Visina (mm)

980

Boja tijela i poklopca

Antracit, boja pijeska (bež), siva

Ukupna visina (mm)

1150

Finncont® Luowia **Divided** - podijeljeni

Sustavi gospodarenja otpadom

16/42



Opremljeni s dvjema odvojenim vrećama za podizanje otpada i pregradnim zidom.

Dostupni za sve spremnike u seriji Finncont® Luowia 5000

Sakupljanje 2 različite frakcije otpada

Različiti otvori na izbor od okruglih (npr. za staklo) do širokih (npr. za papir).

Dvostruki otvori za ubacivanje na glavnom poklopcu



Product

Finncont® Luowia Divided, Surface

Finncont® Luowia Divided, Short

Finncont® Luowia Divided, Deep

Volume (l)

2 x 1200

2 x 1400

2 x 2400

FINNCONT®

CONTINUITY



Finncont® Luowia Link – povezani

Sustavi gospodarenja otpadom

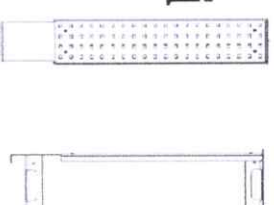

17/42

Instalacija spremnika bliže jedan drugome

Jedinstveno tijelo

Dostupni s aluminijskim i kompozitnim panelima

Zahijeva različiti sustav sidrenja između spremnika

Dostupni za sve serije spremnika

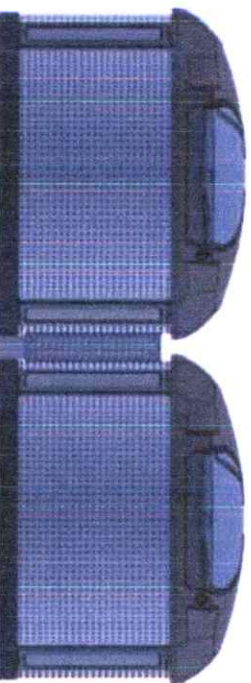

FINNCONT®

CONTINUITY

Finncont® Luowia Modernizacija

Sustavi gospodarenja otpadom

Serijom Finncont® Luowia modernizirat ćete svoj stari spremnik

Ažuriranjem izgleda spremnika, povećat ćete i sigurnost korisnika prema Finncont® Luowia visokim standardima

Serija za modernizaciju spremnika prikladni su za većinu postojećih spremnika na tržištu

Dostupni za sve serije proizvoda

Serija za modernizaciju uključuje:

- ✓ Novi poklopac s odgovarajućim otvorom
- ✓ Novi sustav za podizanje
- ✓ Nova vreća za podizanje
- ✓ Novi gornji/glavni prsten
- ✓ Kutne panele i oznake otpada
- ✓ Aluminijske panele

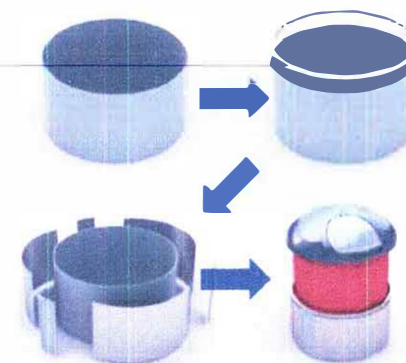

Finncont® Luowia

Vreće za prikupljanje otpada

Odgovara većini podzemnih spremnika
 Prilagođene različitim frakcijama otpada
 Volumeni od 600 litara do 5000 litara
 VTT certificirane (Tehnički istraživački centar, Finska)

3 tipa:

- ✓ PP & PP / PP & PVC Plašt
- ✓ PE & PVC Plašt
- ✓ PVC

PP/PE → tolerancija na teške terete / čvrstoću
 PVC → tolerancija na rezove / fleksibilnost



Sve vreće za podizanje testirane su sukladno
 ISO 21898 SWL 6:1 , mjereno s gustoćom otpada 0,4

uz dodatak tankvane za tekućine
 od 100 do 300 litara



spojena na nosivi obruč
 duž profila obruča

jednostruki plastični
 zatvarač s osiguračem

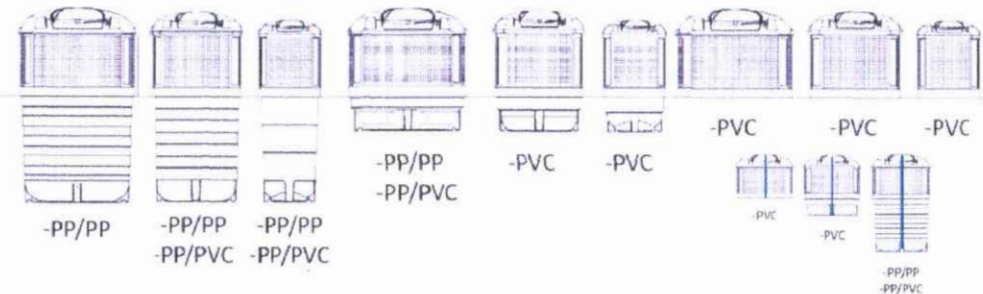

Finncont® Luowia

20/42

Certificate of PE materials

FINNCONT

Producer: Finncont Oy
B.O.Box 44
FI-34801 Virrat
FINLAND

Products: Luowia waste containers including main lid produced from 100% recyclable polyethylene material

Used PE material:
Recycled polyethylene material for rotomolding which is 100% recyclable.

Virrat 1st Feb 2021

Hannu Ranta-Lassila
Deputy Managing Director

Finncont Oy
B.O.Box 44, Siltatie 10, FI-34801, Virrat, Finland
Tel: +358 (0)9 480 411 / Fax: +358 (0)9 480 430
M/F: 000 77491 / 000 817260208



Certificate of PE materials

FINNCONT

Producer: Finncont Oy
B.O.Box 44
FI-34801 Virrat
FINLAND

Products: Luowia waste containers including main lid are produced from 100% virgin polyethylene material

Used PE material:
Linear polyethylene grade for rotomolding which is 100% recyclable.

Virrat 1st Feb 2021

Hannu Ranta-Lassila
Deputy Managing Director

Finncont Oy
B.O.Box 44, Siltatie 10, FI-34801, Virrat, Finland
Tel: +358 (0)9 480 411 / Fax: +358 (0)9 480 430
M/F: 000 77491 / 000 817260208



Luowia spremnici za otpad uključujući i glavni poklopac, proizvedeni su od 100% polietilenskog materijala koji se može reciklirati.

FINNCONT®

CONTINUITY

FINNCONVT[®]

21/42

Finncont[®] Luowia

Specifičnosti

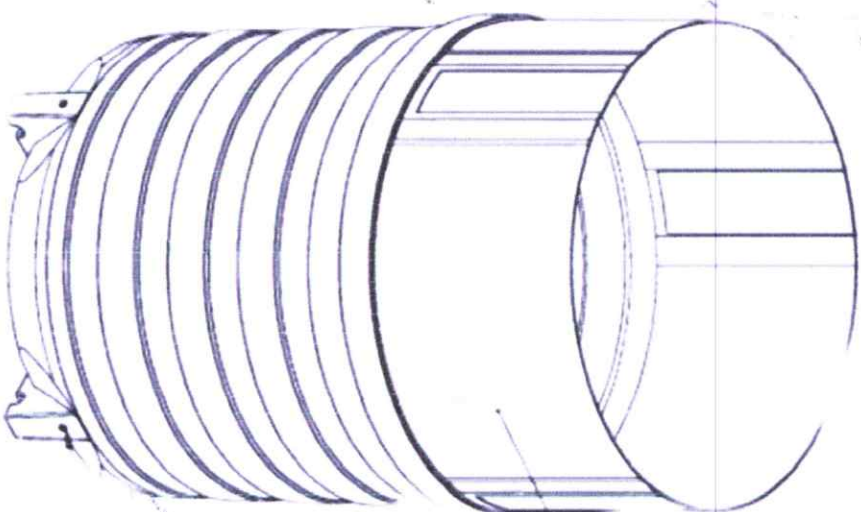
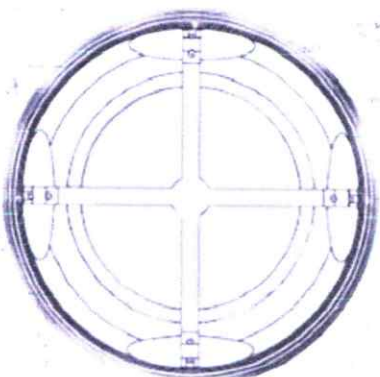
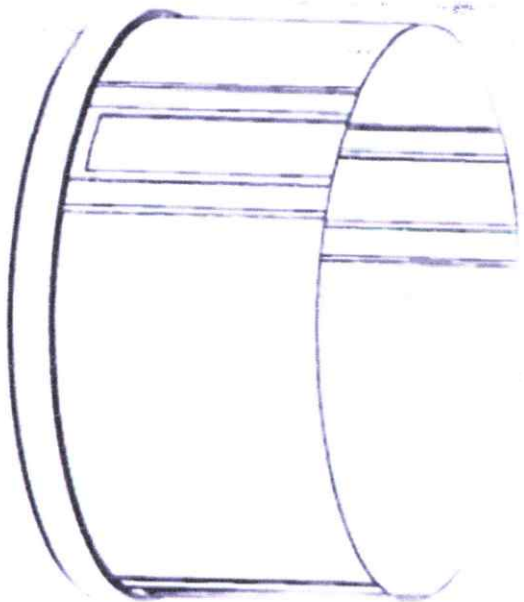

FINNCONVT[®]

CONTINUITY

Finncont® Luowia

Glavni poklopac

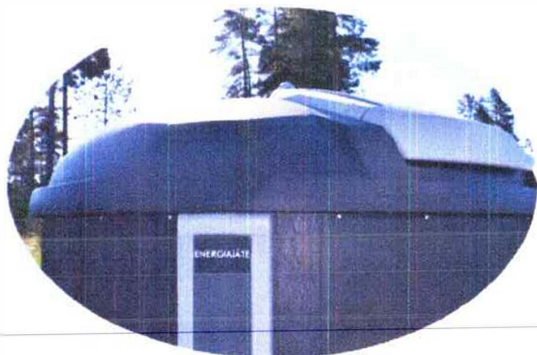

Centrifugalno ekstrudirana plastika HDPE

Testiran na velikim snježnim opterećenjima

EN 13071-1

Različiti otvori ovisno o frakciji otpada

antracit, boja pijeska (bež), siva

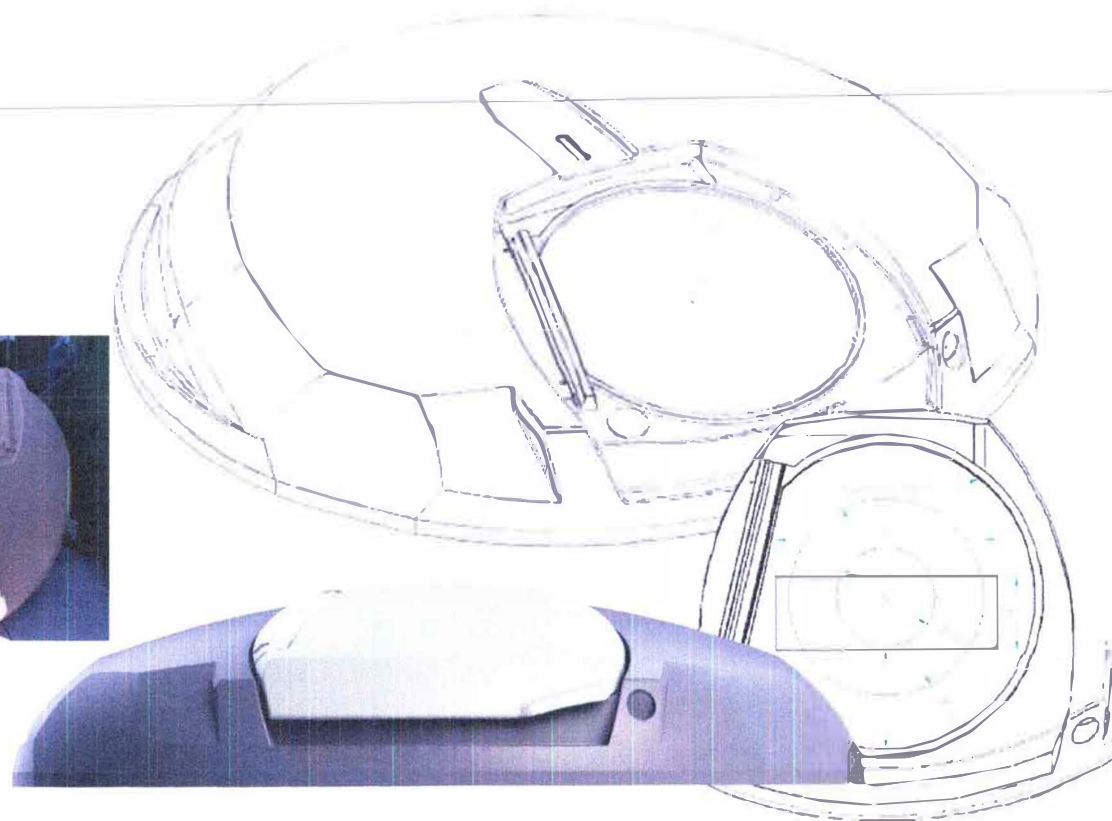
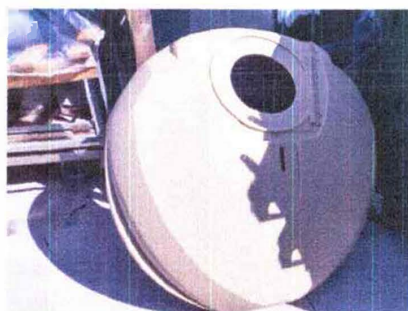

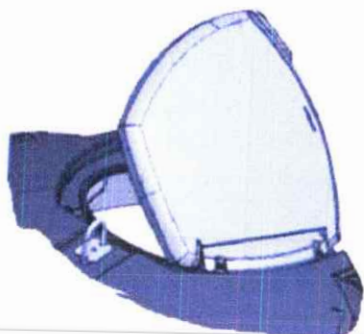

Finncont® Luowia

Poklopac za ubacivanje otpada

23/42

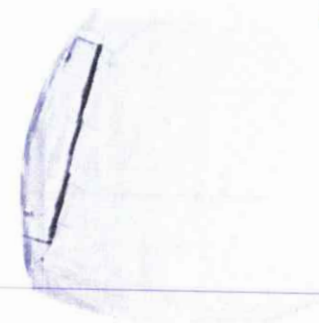

Poklopac za ubacivanje otpada integriran šarkama u tijelo spremnika

Centrifugalno ekstrudirana plastika HDPE

Boja: svijetlo siva, bež ili druga boja po zahtjevu kupca

Može se naknadno ugraditi

(Važno! Ukoliko stari poklopac za ubacivanje ima sistem zaključavanja, ne može se naknadno ugraditi)

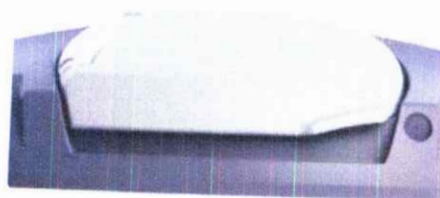

FINNCONT®

CONTINUITY



Finncont® Luowia

Poklopac za ubacivanje otpada - drum lid

Otvor za ubacivanje otpada izveden kao rotirajući bubanj - drum lid

Standardna boja: siva i bijela

Otvor za ubacivanje otpada dimenzija 500x400 mm i moguće ga je prilagoditi drugoj dimenziji ukoliko je potrebno.

Izrađen od kvalitetnog čeličnog lima.

Dostupni u različitim volumenima - uređaj ima mogućnost instalacije umetka kojim se po želji korisnika može smanjiti volumen na traženi po zahtjevu kupca, od 35-75 litara.

Predviđeno mjesto za ugradnju bravice u donjem desnom kutu, zaštićeno od utjecaja atmosferilija.



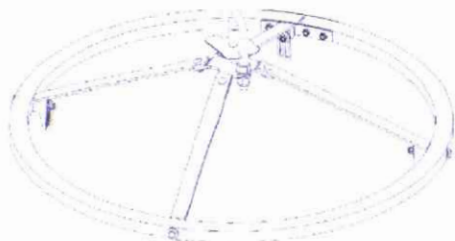

Finncont® Luowia

Sistem za podizanje

Sistem za podizanje u 1 točki, sistem jednostruke kuke single hook

Aluminijski prsten za podizanje

Aluminijski držači prstena za podizanje

Čelične šipke i središnja ploča presvučeni vrućim cinkom

Pokrivna ploča od nehrđajućeg čelika

SWL 3:1 (sigurnosno radno opterećenje)
EN-13155+A2

- ✓ 5000 serija → 2000kg
- ✓ 3000 serija → 1500kg
- ✓ 1300 serija → 700kg

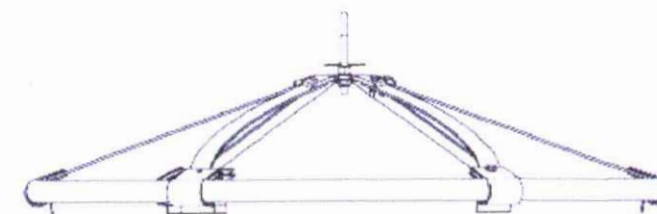
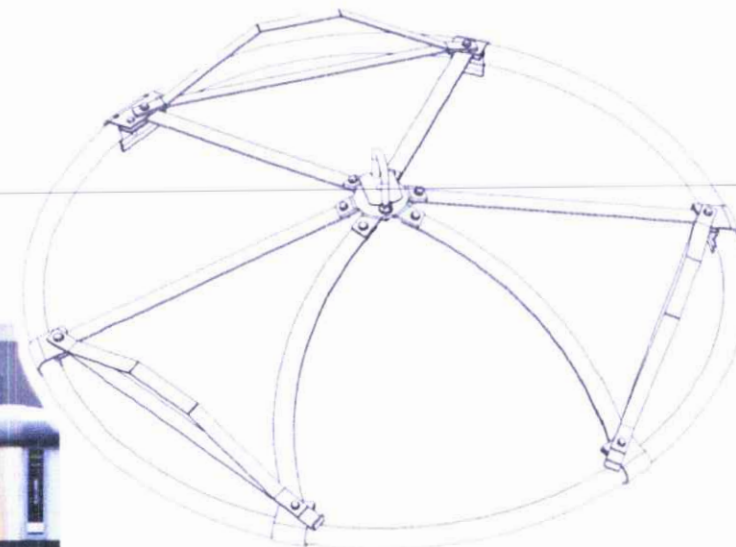

Finncont® Luowia

Poklopci sa šarkama-zglobni poklopci

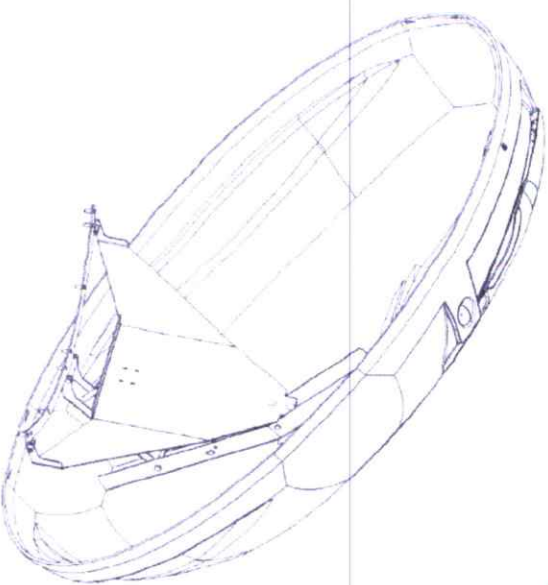

Potpomognut plinskim amortizerom

Čelični dijelovi presvučeni vrućim cinkom

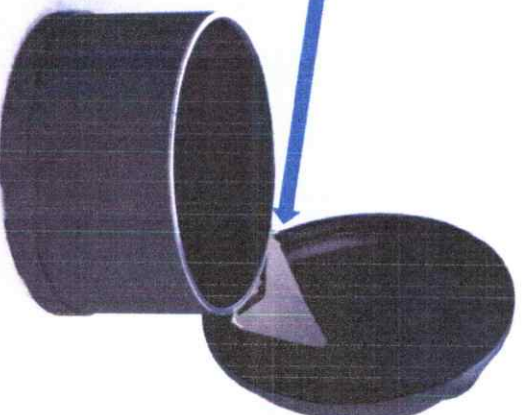

- Dostupni za:**
- ✓ 5000 serija
 - ✓ Podijeljeni

Na vanjskom vršnom dijelu polietilenskog uloška nalazi se metalni obruč na vrhu koji služi za održavanje oblika spremnika kada je ukopan

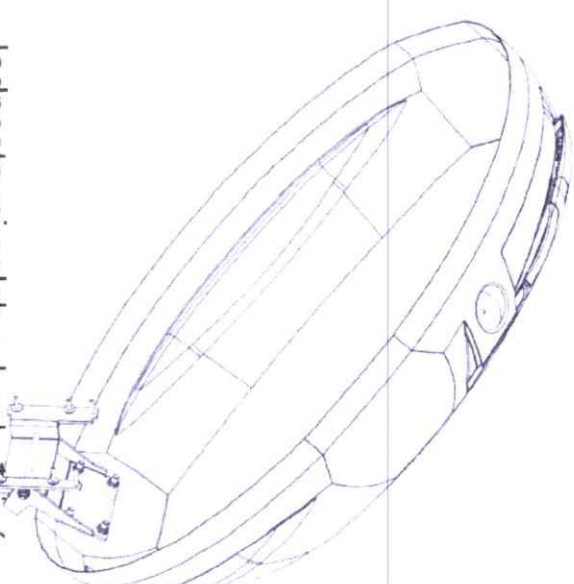

Jednostavni zglob od nehrđajućeg čelika

Stražnju bočnu ploču potrebno je izmijeniti kad se instalira poklopac

- Dostupni za:**
- ✓ 1300 serija

Finncont® Luowia

Sustav za sidrenje

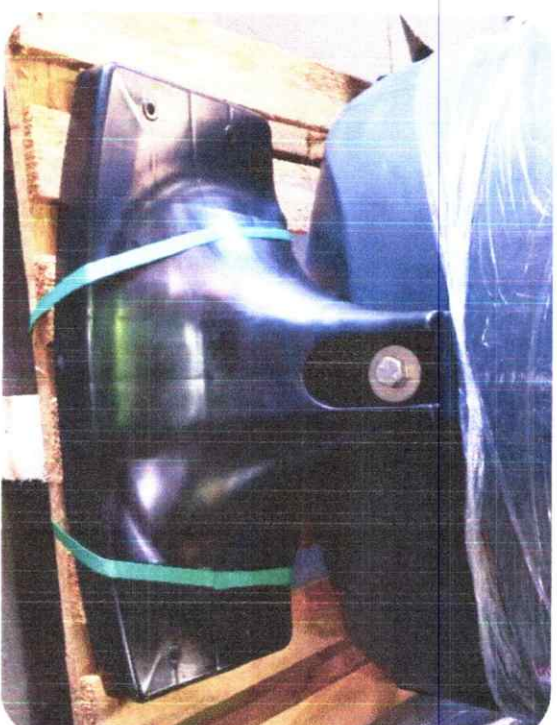
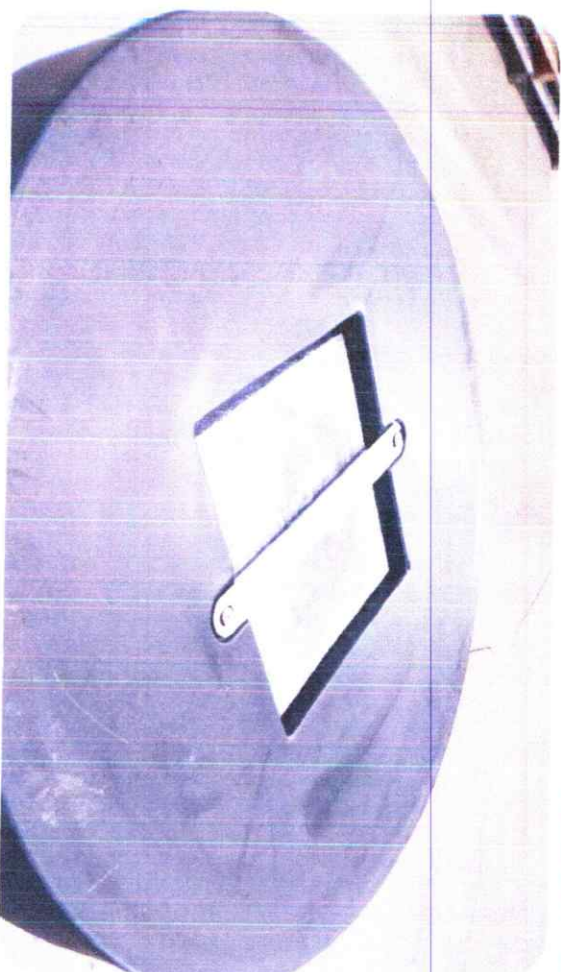

Finncont® Luowia Nadzemni

Džep za betonsku ploču na dnu spremnika
Za bolju stabilnost spremnika

Finncont® Luowia Deep / Short

Mogućnost podešavanja visine

Peraja za
sidrenje



Finncont® Luowia

Opције izmjenjivih panela

Aluminijski

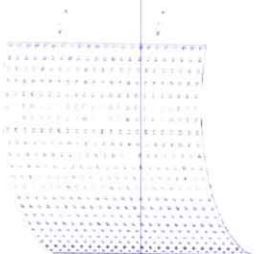

- Standardni aluminiij
- Opcija aluminiij u boji
 - ✓ Standardne boje
 - ✓ Prikladne RAL-boje



Kompozitni

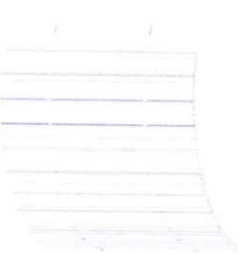

- Boja tijela i poklopca: bež boja pijeska, plašt imitacija kamena
- Vrlo lako se postavlja na vanjski dio tijela spremnika i ne dolaze u kontakt s vrećom za sakupljanje otpada

Oglasni

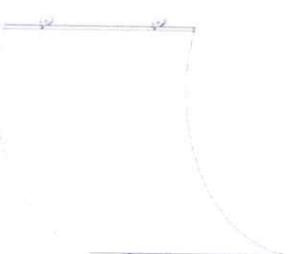

- Printanje na plastici
- Lako zamjenjivi
- 1-3 kom/spremnik



Bez panela



Finncont® Luowia

Aluminijski

29/42

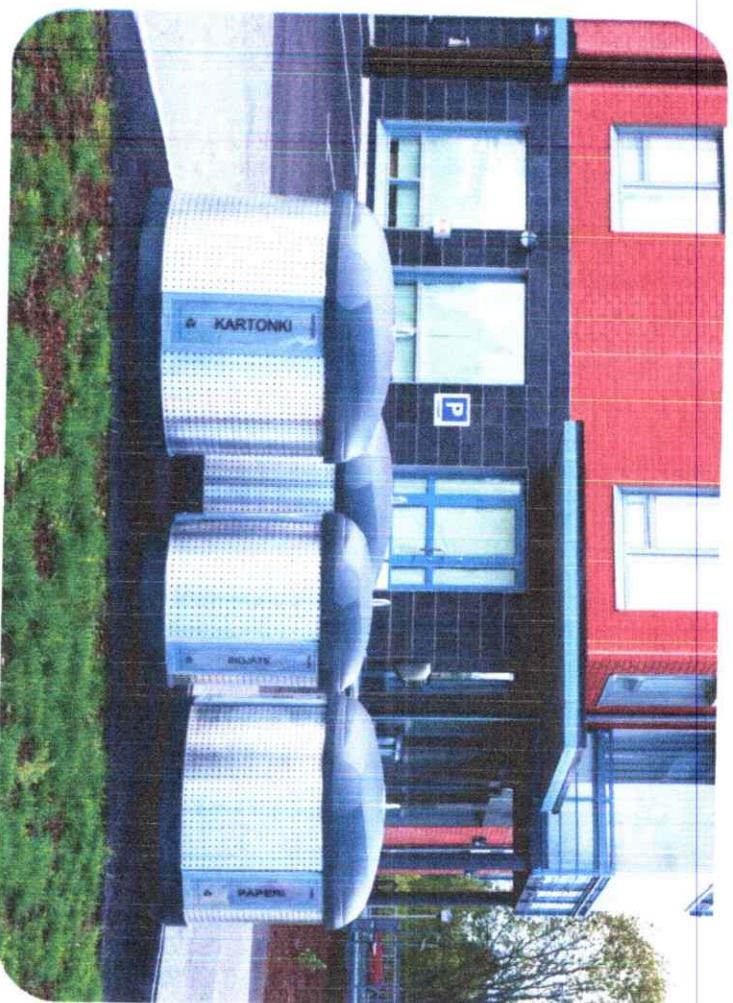

FINNCONT®

CONTINUITY

Finncont® Luowia

Kompozitni



FINNCONT®

CONTINUITY

Finncont® Luowia

Oglašavanje



Finncont® Luowia

Bez panela - antracit / boja pijeska

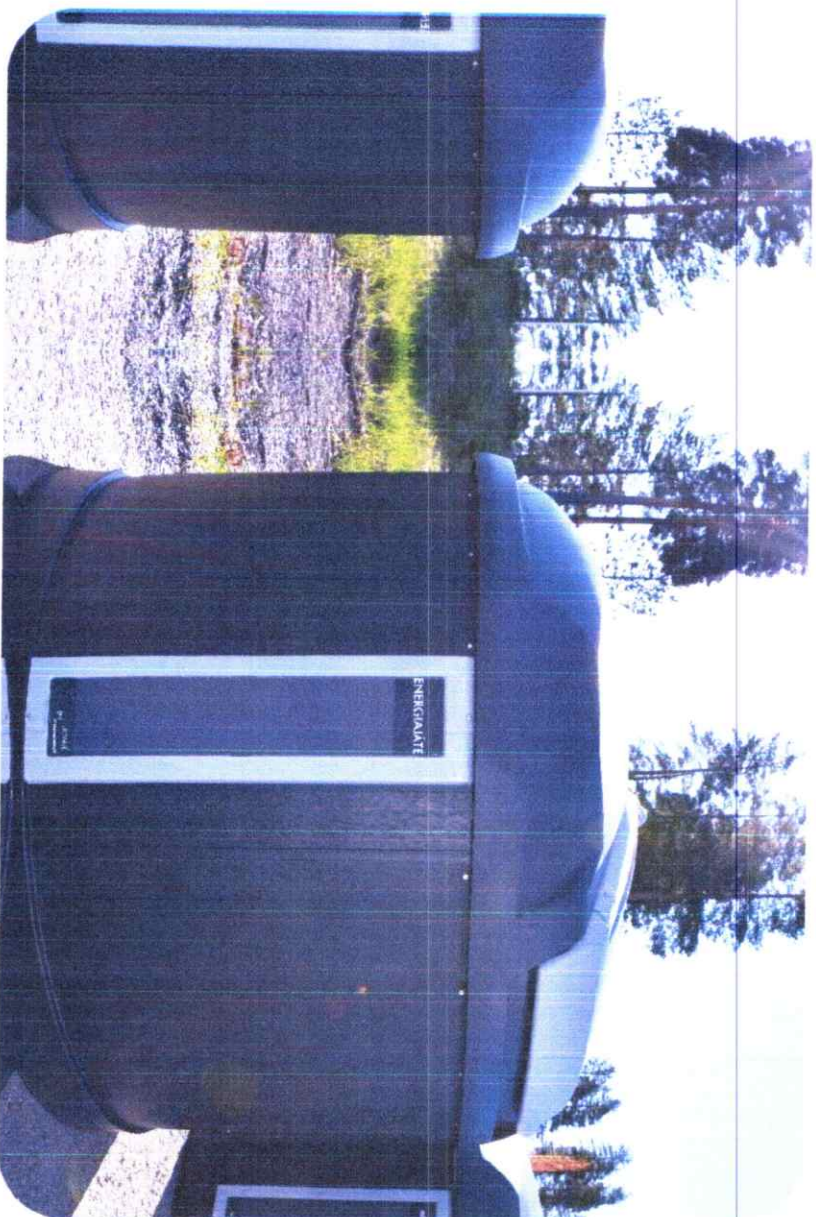

Finncont® Luowia – opcije otvora za ubacivanje otpada

5000 serija

- 600 = puni otvor (max. širina 555 mm, max. visina 610 mm)
- 200 (otvor za boce) = 200 mm okrugli otvor u sredini prostora
- Otvor za papir/karton = 450 x 150
- mogućnost prilagodbe dimenzije i oblika otvora po zahtjevu kupca

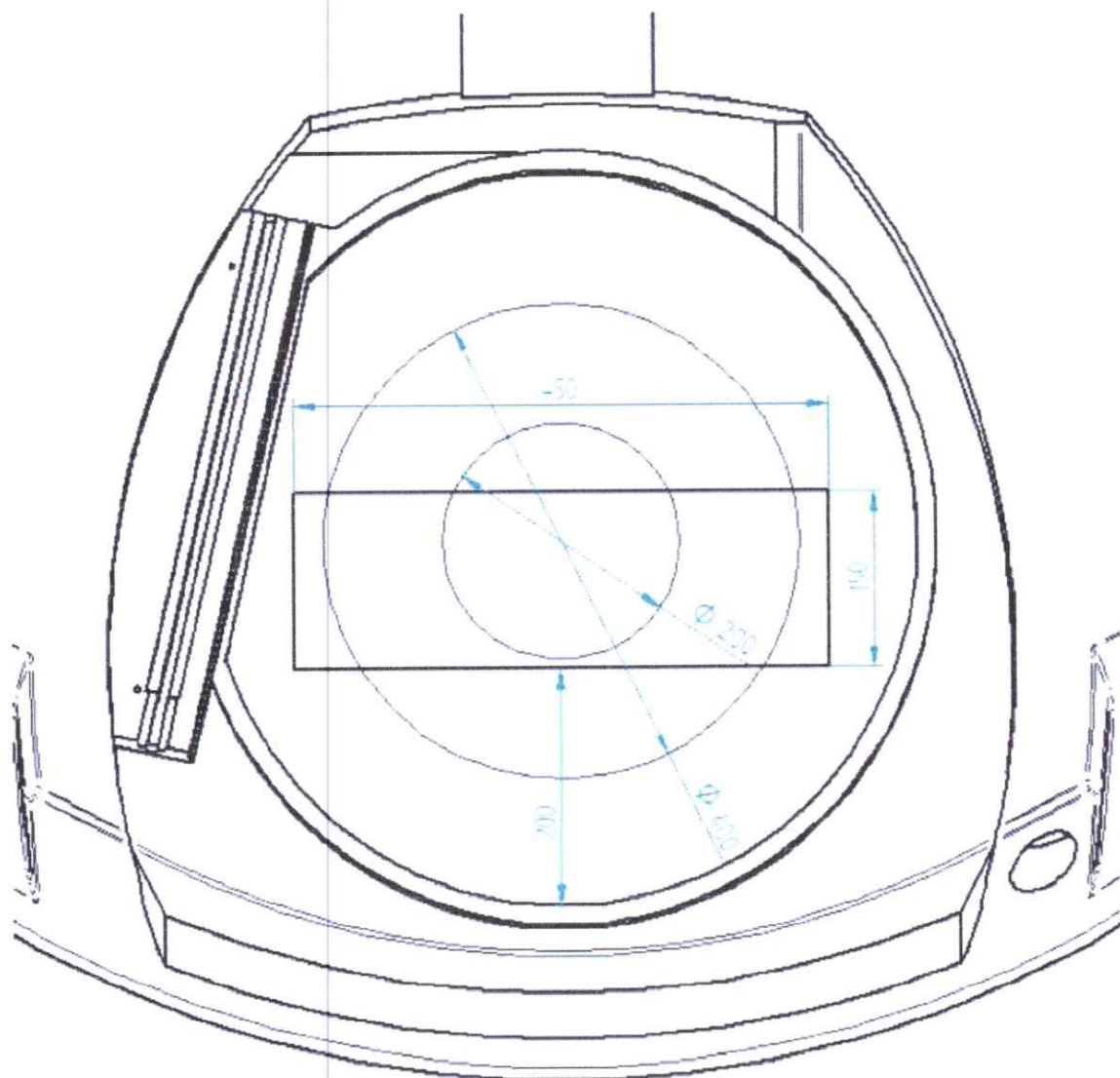

Finncont

VIRRAT: P.O. Box 44, Kiertotie 10-12, FI-34801 Virrat, Finland | +358 3 485 411 | ALV rek./VAT reg. FI17407026

LAHTI: Valimonkatu 2, FI-15100 Lahti, Finland | +358 3 872 020 | ALV rek./VAT reg. FI20980480

GÖTEBORG: Kungsporten 4A SE-427 50 Billdal | VAT reg. SE559204280701

www.finncont.com

3000 serija

- 450 = puni otvor (max. širina 435 mm, max. visina 455 mm)
- 200 (otvor za boce) = 200 mm okrugli otvor u sredini prostora
- Otvor za papir/karton = 380 x 150
- mogućnost prilagodbe dimenzije i oblika otvora po zahtjevu kupca

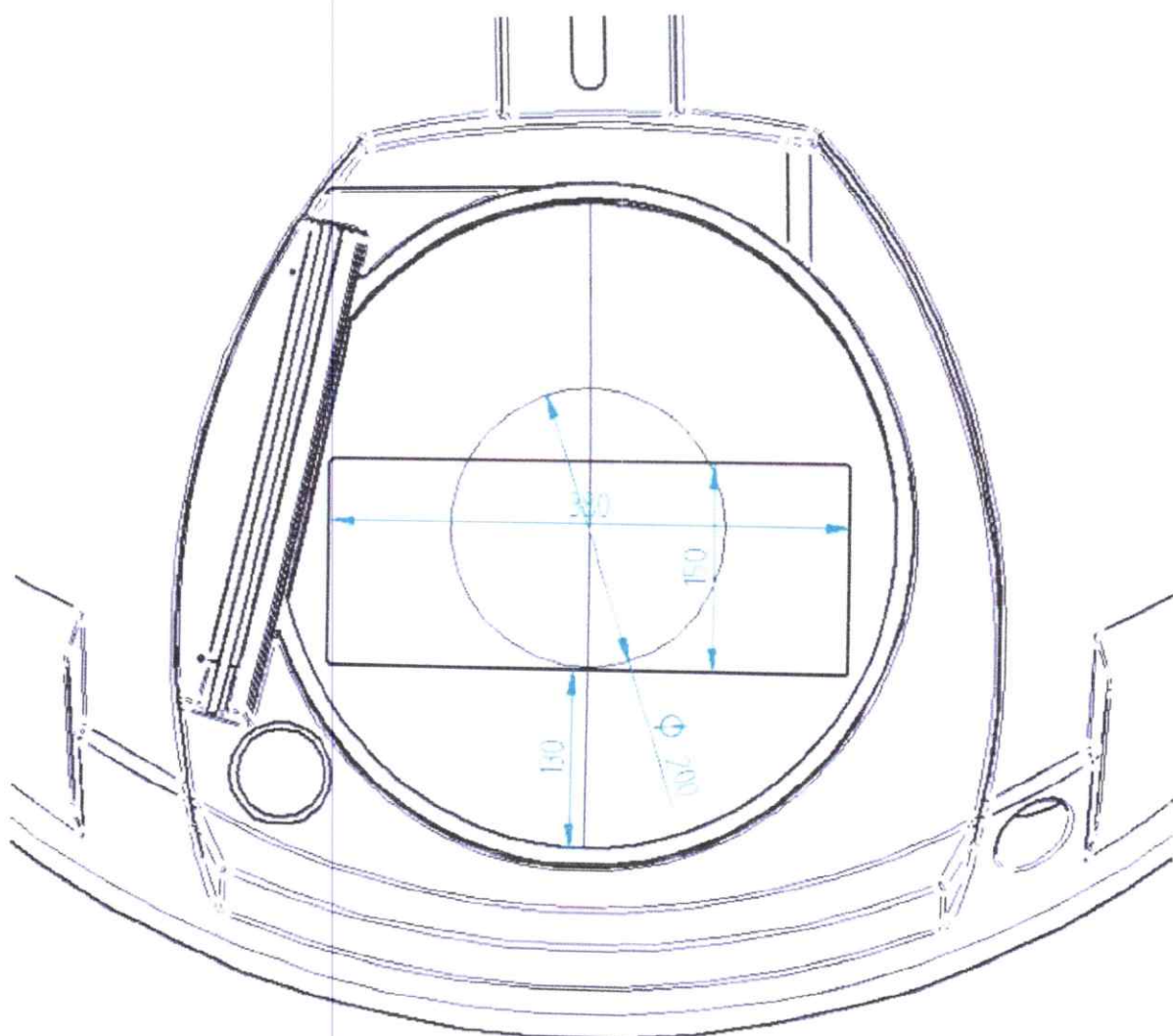

1300 serija

- 300 = puni otvor (max. širina 300 mm, max. visina 310 mm)
- 200 (otvor za boce) = 200 mm okrugli otvor u sredini prostora
- otvor za papir/karton = puni otvor
- mogućnost prilagodbe dimenzije i oblika otvora po zahtjevu kupca

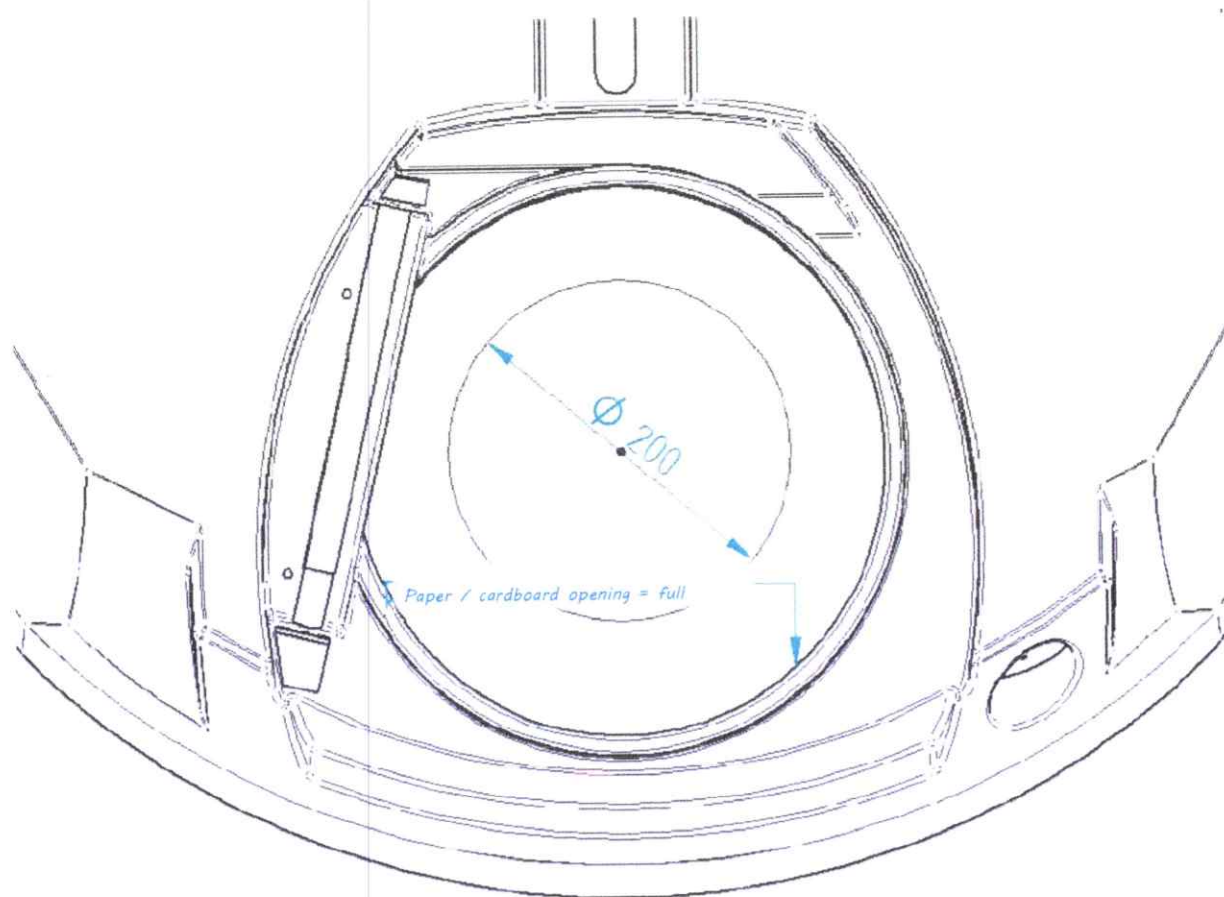

Finncont

VIRRRAT: P.O. Box 44, Kiertotie 10-12, FI-34801 Virrat, Finland | +358 3 485 411 | ALV rek./VAT reg. FI17407026

LAHTI: Valimonkatu 2, FI-15100 Lahti, Finland | +358 3 872 020 | ALV rek./VAT reg. FI20980480

GÖTEBORG: Kungsposten 4A SE-427 50 Billdal | VAT reg. SE559204280701

www.finncont.com

Finncont® Luowia

Bočni paneli i oznake otpada



3 bočna izmjenjiva natpisa pričvršćena na spremniku -
tisak po želji kupca ravnomjerno raspoređeni u krug
svakih 120 stupnjeva

Centrifugalno ekstrudirana plastika HDPE

Boja i izvedba: sukladno zahtjevu kupca

Stilizirane oznake otpada za personaliziranje spremnika

Koristite naše predloške oznaka za otpad ili dizajnirajte
vlastite i na taj način promovirajte odvojeno sakupljanje
otpada



690

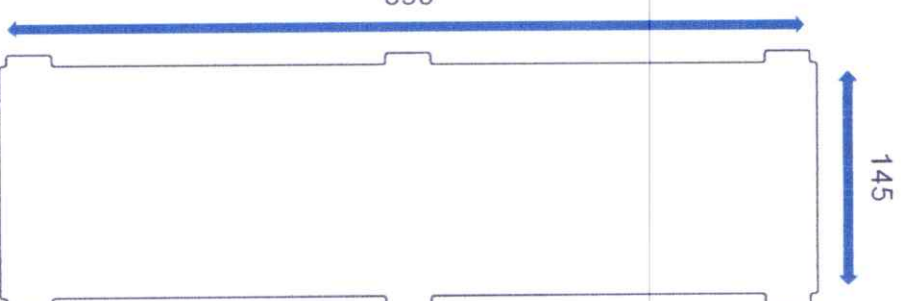

Finncont® Luowia

Sistem za zaključavanje

Dostupni sistemi za zaključavanje:

- ✓ Abloy (CL103)
- ✓ Assa (10460 + 10450)
- ✓ Kaba (1071H)
- ✓ Ruko (1607 Kr L OP)
- ✓ Iloq C10S.5
- ✓ Dom (sigma 382)
- ✓ Upravljanje i nadzor pristupa

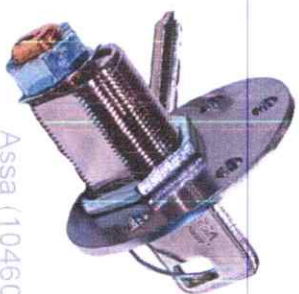

Assa (10460)

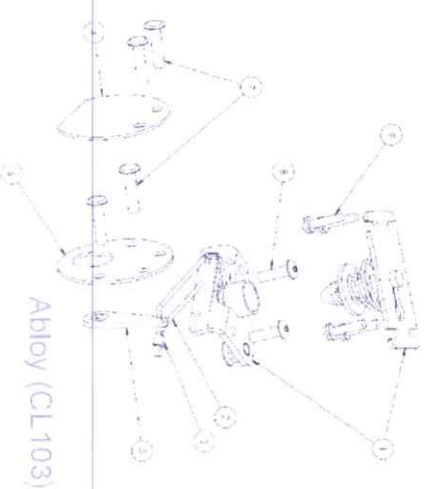

Abloy (CL103)

Luowia nudi instalacijsku seriju za ugradnju mehanizma za zaključavanje, koji se nalazi na glavnom poklopcu spremnika

Cilindar za zaključavanje (bravica) standardno nije uključen

Može se naknadno ugraditi, ali najbolje je ugraditi direktno u proizvodnji.

Za zglobne poklopce postoji i zasun za zaključavanje lokota



Finncont® Luowia

Proizvođačka naljepnica

Luowia

FINNCONT LUOWIA OY
Kirkko 4 • O-212400 VIERASTI FINLAND
www.luowia.com

Size	Type	Item code	SWL	SF
<input type="checkbox"/> 5000/5000	mixed waste	R-3LUO-0711	2000 kg	6:1
<input type="checkbox"/> 5000/3000	mixed waste	R-3LUO-0717	1200 kg	6:1
<input type="checkbox"/> 5000/3000	glass	R-3LUO-0718	1200 kg	6:1
<input type="checkbox"/> 5000/2500	mixed/glass	R-3LUO-0719	1000 kg	6:1

TESTED ACCORDING ISO 21898 - STANDARD DUTY REUSABLE
Labor data / VTT type test certificate numbers: 9023 S/14-1, 9023 6/14-1, VTT-K-00999-15
Test certificate dates: 15.1.2014, 18.8.2015

PULL LIFTING HOOP INTO LIFTING LOOP

START LIFTING SLOWLY

LIFTING ONLY STRAIGHT UP

DO NOT RECOMMENCED TO USE CHAIN

NOTE SWL OF THE LIFTING BAG

KOHOKU NIIMITETTÄÄN NOSTOVAIKUTUKSEN
ALUSTA NOSTOTIETÄ RAUHALLISESTI
KOSTO ZAPARTTU SUORAAN KOHTI SUORAAN
NOSTAmaan, KETJUA KÄYTTÖ SUORITETTAVAA
TÄRKEINNETÄSSÄ TULEE HUOMIOWIDA
NOSTOSÄÄNNÄ SWL - ARVO

LABEL NO. LI

ALWAYS INSPECT THE LIFTING BAG AFTER DISCHARGING!
TARKASTA SÄÄRI AINA TYHJENNÄYSEN AJAKSENI



USE APPROVED CHAIN OR SLING ONLY
KÄYTTÄ VAIN HYVÄKÄYTTÄÄ KETJUA TAI LAINAA

THE MATERIAL / VALMISTUSMATERIAALI



PP

TIME OF MANUFACTURE: SEE FLAP SIDE
VALMISTUSAJANKA KÄYTTÖ KÄÄNTÄPÖLKE



ACCCON SIKOMI OY
Välkyläntie 9, 0-2700 KOKKOLA, FINLAND
Tel. +358 5 4248 300
info@acccon.fi

LIFTING BAG MANUFACTURER
NOSTUSÄÄNNÄ VALMISTAJA

Naljepnica vreće za podizanje

FINNCONT®

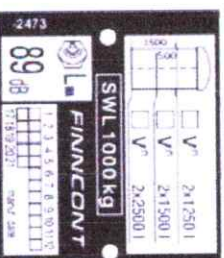
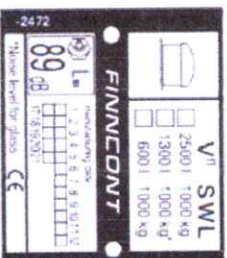
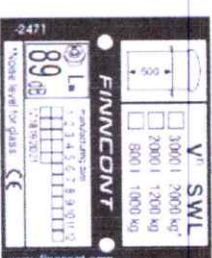
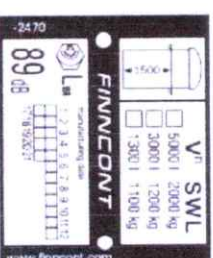
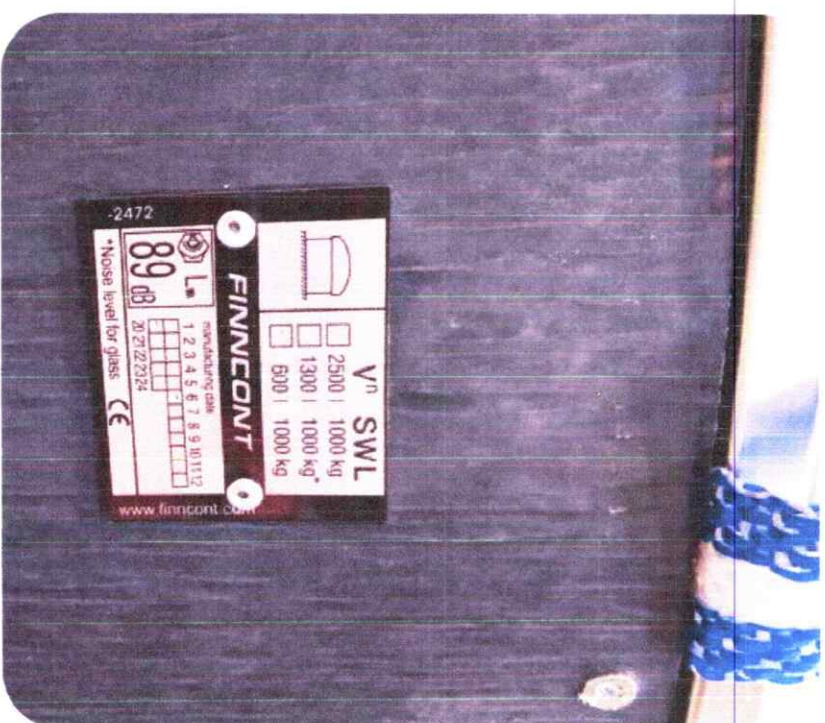

CONTINUITY

Finncont® Luowia

Proizvodi tijekom transporta

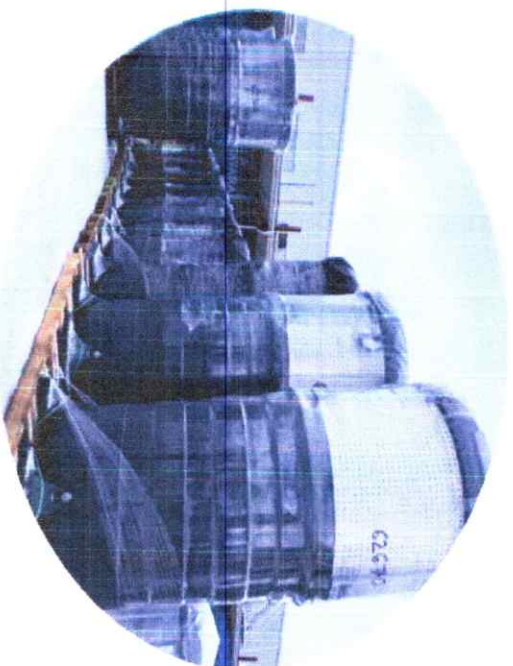

Paleta gotova za transport povećava visinu proizvoda za 13 cm

Utjecaj na širinu tijekom transporta različit je od proizvoda do proizvoda.

(Paleta nema utjecaj na širinu proizvoda kod većine proizvoda)

130 2800



FINNCONT®

CONTINUITY

Finncont® Luowia

Ugradnja

40/42

- 5000 Deep
- 3000 Deep
- 1300 Deep

- 3000 Short
- 2000 Short
- 800 Short

- 2500 Surface
- 1300 Surface
- 600 Surface

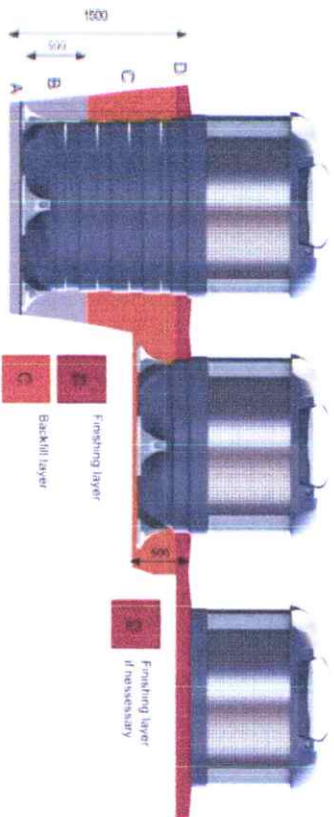

- D Finishing layer
- C Backfill layer
- B Anchoring layer
- A Base layer

- D Finishing layer
- C Backfill layer

- D Finishing layer if necessary

FINNCONT®
Luowia installation - VIDEO

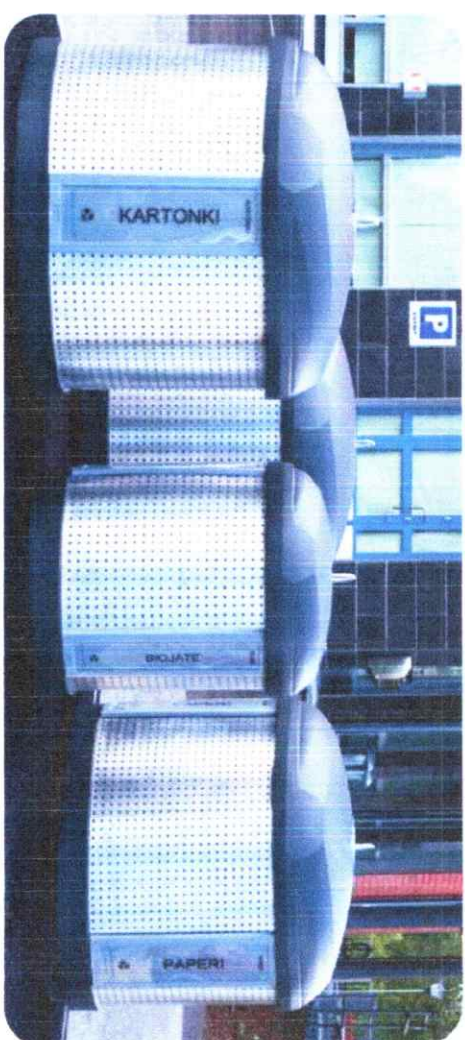

FINNCONT®

CONTINUITY



Podržavamo mogućnosti na ih kupaca da djeluju pametno,
učinkovito i na odgovoran način, proizvodeći održiva rješenja
u gospodarenju otpadom.

FANNECOMT®
CONTINUITY

